

Mont Blanc®

MB RoofBars Flex 3 clamp foot BU2 + FK222

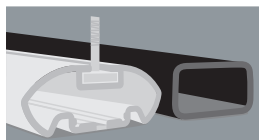

118 cm

Mazda 5 5dr MPV 2010-

DE Montageanleitung
GB Fitting instructions
SE Monteringsanvisning
FR Instructions de montage
RU Инструкция по сборке

FI Asennusohjeet
NL Montagevoorschrift
ES Instrucciones de montaje
IT Istruzioni per componenti
PL Instrukcja montażu

DE WICHTIG:

- Vor Erstgebrauch lesen.
- Montage nur nach dieser Vorlage durchführen.
- Vorlage im Fahrzeug mitführen.
- Geltende Rechte und Vorschriften müssen verfolgt werden bezüglich Verwendungsweise für Lastenträger und Zubehör.
- Vor der Montage und Anwendung des Produkts, diese Montageanleitung sehr genau durchlesen. Bei eventuellen Unklarheiten bitte setzen Sie sich mit Ihrem Händler in Verbindung.

GB WARNING !

- Read these instructions carefully before using the product for the first time.
- Assemble and fit the product using these instructions only.
- Keep instructions in car.
- Be sure to follow the national rules and legislations in force regarding method of application of load carrier and accessories.
- Do not assemble or use this product unless you have understood the fitting instruction. If you have any questions, please contact your local dealer for further information.

SE VARNING !

- Läs igenom anvisningen noggrant innan produkten tas i bruk.
- Montera endast enligt denna beskrivning.
- Monteringsanvisningen skall medföras i bilen.
- Gällande nationella lagkrav och föreskrifter skall följas vad avser användningssätt för lasthållare och tillbehör.
- Montera och använd inte produkten förrän du har förstått monteringsanvisningen.
- Vid eventuella oklarheter, kontakta återförsäljaren.

FR IMPORTANT:

- A lire soigneusement avant la première utilisation
- Pour le montage, se conformer strictement aux présentes instructions
- Les instructions doivent nécessairement se trouver dans le véhicule
- Les arrêtés et lois nationaux en vigueur doivent être suivis lors de l'emploi du porte-bagages et de ses accessoires
- Ne pas assembler et ne pas utiliser le produit avant de lire les instructions de montage. Prendre contact avec le fournisseur lors de problèmes éventuels.

FI TÄRKEÄÄ:

- Luettava ennen ensimmäistä käyttöönottoa.
- Asennus vain tämän ohjeen mukaan.
- Pidettävä mukana ajoneuvossa.
- Taakkatelineiden ja niiden lisätarvikkeiden käyttöä koskevia kansallisia lakeja ja muita säännöksiä on aina noudatettava.
- Älä asenna äläkä käytä tuotetta ennen kuin olet ymmärtänyt asennusohjeet. Ota yhteys jälleenmyyjään epäselvissä tapauksissa.

NL BELANGRIJK:

- Voor gebruik goed doorlezen.
- Montage alleen volgens dit voorbeeld uitvoeren.
- Montagevoorschrift in de auto bewaren.
- Wettelijke regels en voorschriften ten aanzien van gebruik van allesdragers en accessoires moeten in acht worden genomen.
- Dit product niet monteren en gebruiken voordat het montagevoorschrift geheel duidelijk is. Wend U met eventuele vragen tot de plaatselijke dealer.

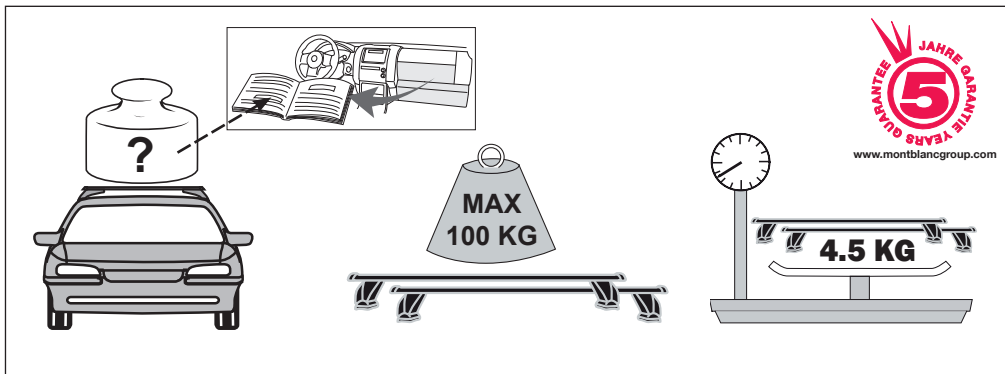

ES IMPORTANTE:

- Leer antes del primer uso.
- Realizar el montaje unicamente conforme a estas instrucciones.
- Llevar las instrucciones en el vehículo.
- Reglas nacionales exigidas e instrucciones vigentes tienen que ser cumplidas al respecto del modo de uso de carga equipajes y accesorios.
- No monte o utilice este producto hasta que haya comprendido las instrucciones de montaje. Si tiene alguna pregunta, por favor pongase en contacto con su distribuidor para más información.

IT INFORMAZIONI:

- Leggere accuratamente le istruzioni prima di usare il prodotto per la prima volta
- Adattare la ruota seguendo solo queste istruzioni.
- Tenere le istruzioni in auto
- Assicurarsi di seguire le norme nazionali e le leggi in vigore riguardanti il metodo di applicazione del portapacchi e accessori
- Non assemblare o usare questo prodotto salvo aver capito le istruzioni per l'uso. Per qualsiasi domanda, contattare il rivenditore locale per ulteriori.

RU Предупреждение!

- Внимательно прочитайте инструкцию перед использованием продукта в первый раз
- Установите багажную систему, только используя инструкцию
- Держите инструкцию в машине
- Удостоверьтесь, что способ применения багажной системы и аксессуаров не противоречит Законодательству РФ
- Не собирайте и не используйте продукт, пока вы не поймете инструкцию по установке. Если в процессе установки у Вас возникли вопросы, свяжитесь с Вашим продавцом для получения необходимой информации.

PL Ważne:

- Przed pierwszym użyciem przeczytać.
- Montaż przeprowadzić zgodnie z niniejszą instrukcją.
- Instrukcję należy umieścić w samochodzie.
- Należy stosować się do obowiązujących przepisów dotyczących sposobu korzystania z bagażników i wyposażenia.
- Przed zamontowaniem i użyciem niniejszego produktu należy bardzo dokładnie przeczytać niniejszą instrukcję montażu. W przypadku niejasności należy porozumieć się ze sprzedawcą.

PT Atenção:

- Ler antes de utilizar
- Realizar a montagem conforme estas indicações
- Recomendamos manter estas instruções no seu automóvel
- Cumprir as regras nacionais e respectiva legislação a respeito do modo de utilização de carga e acessórios
- Não montar ou utilizar este produto sem ter compreendido e entendido as instruções de montagem. Se tiver alguma questão queira por favor entrar em contacto com o distribuidor nacional.

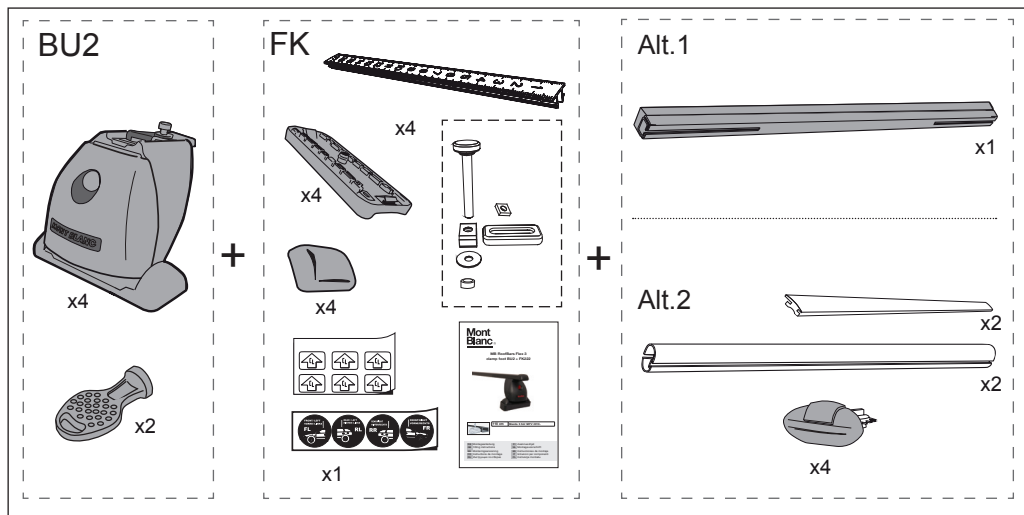

1

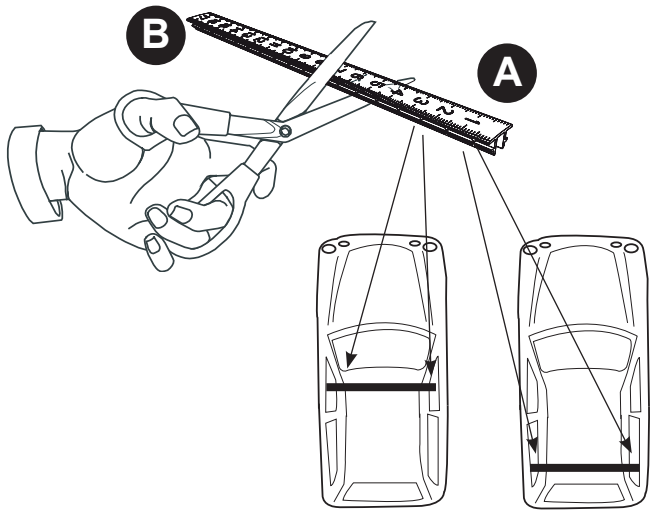

Mazda 5 5dr MPV 2010-

11.0 cm

8.8 cm

2

OK!

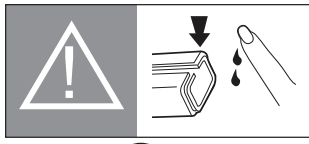

A

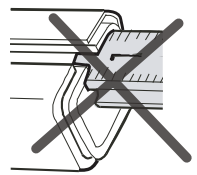

OK!

A



3

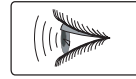
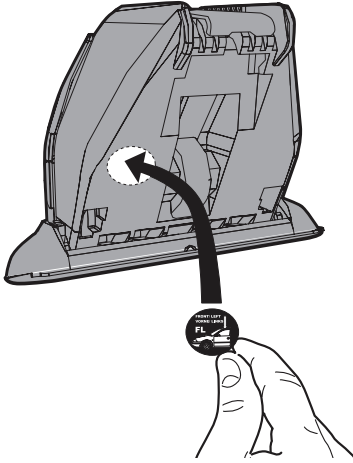

4

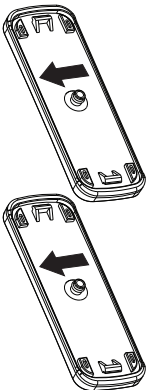
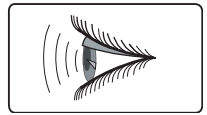
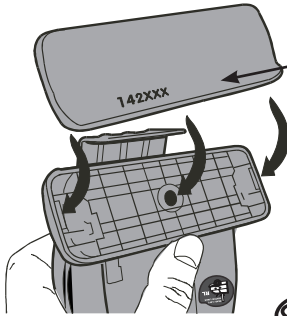

142700



142700

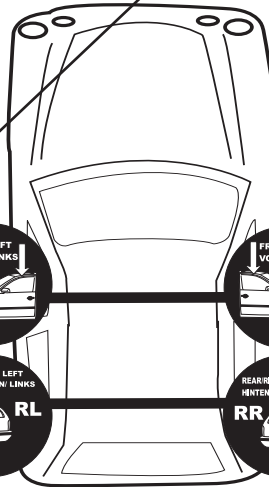

142700

142700

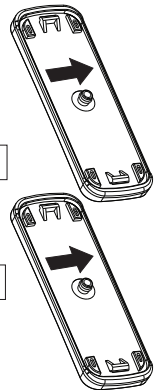

5

Alt. 1

Alt. 2

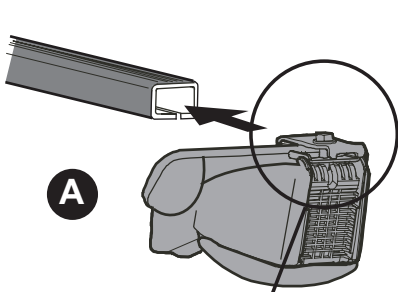

A

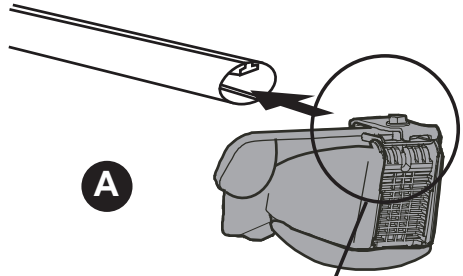

A

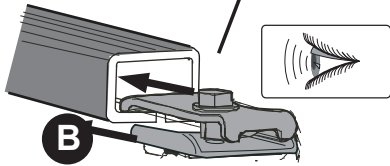

B

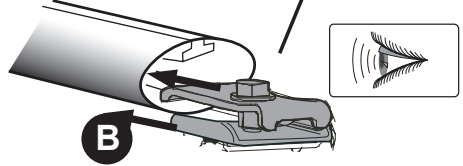

B

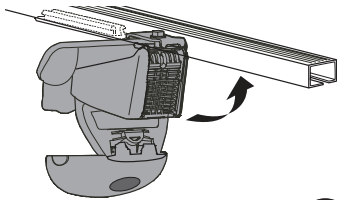

C

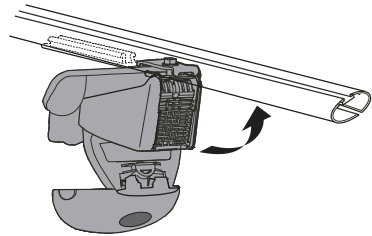

OK

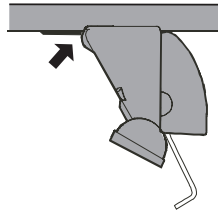

=0



OK!

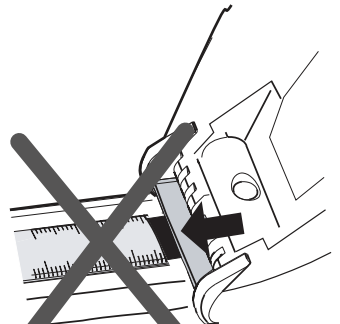

6

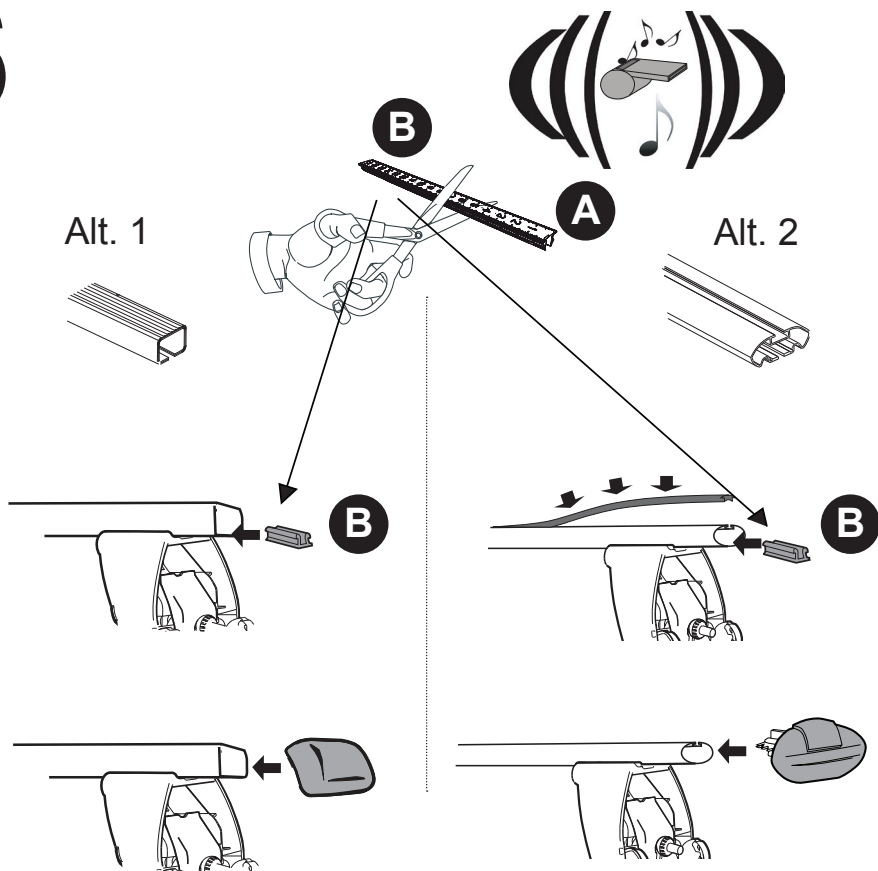

7



8

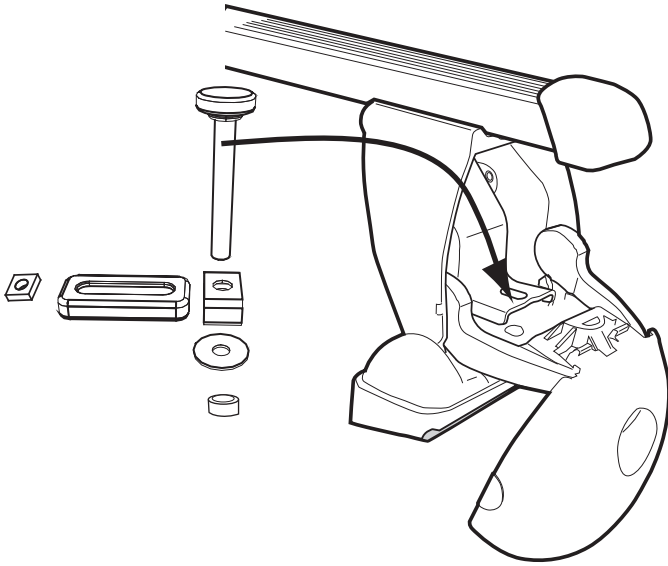

9

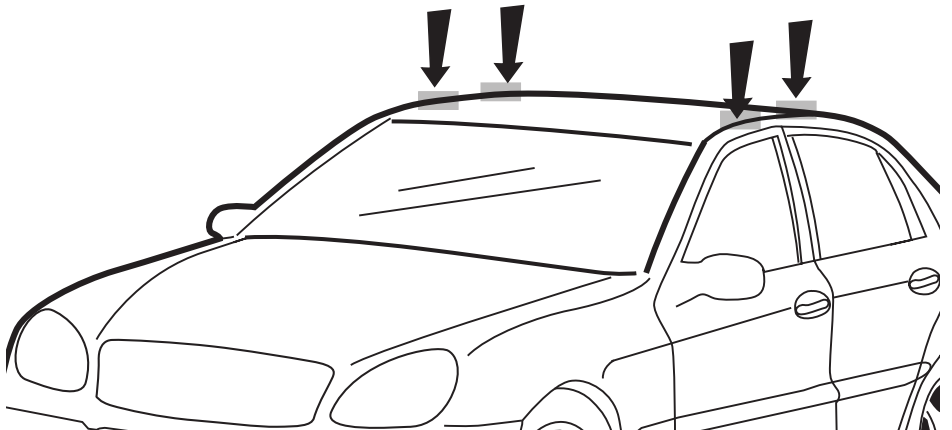
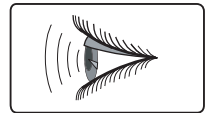
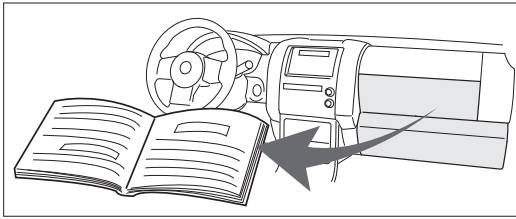

10

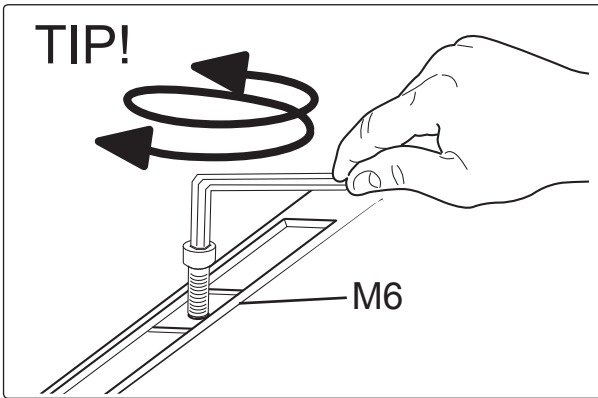
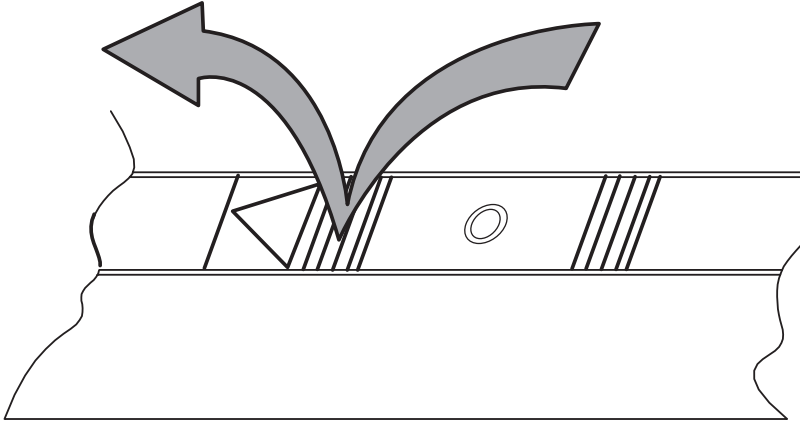

11

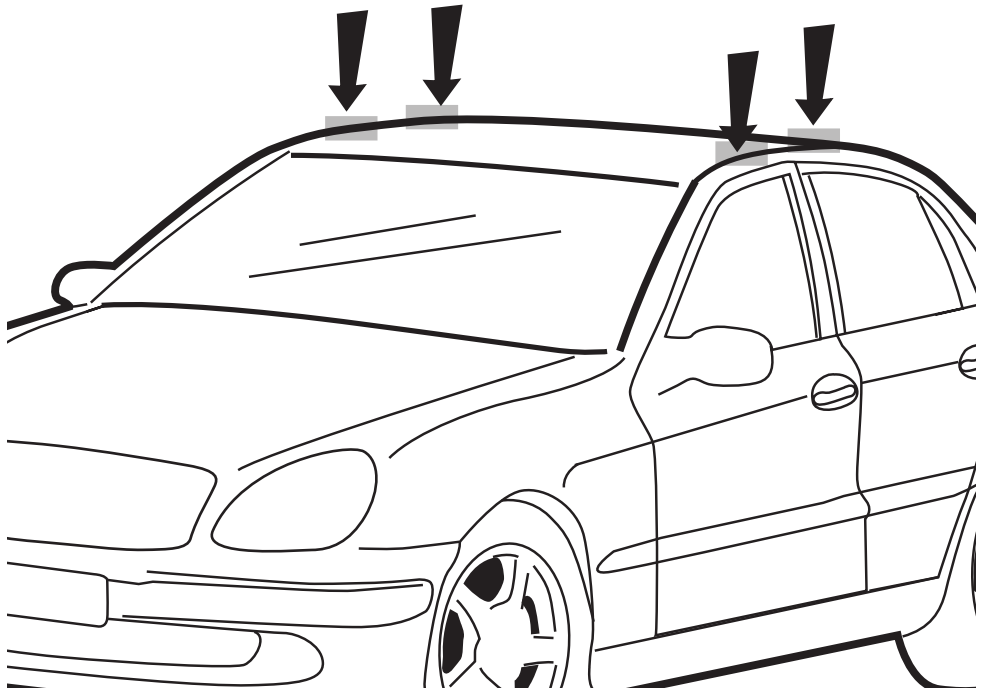
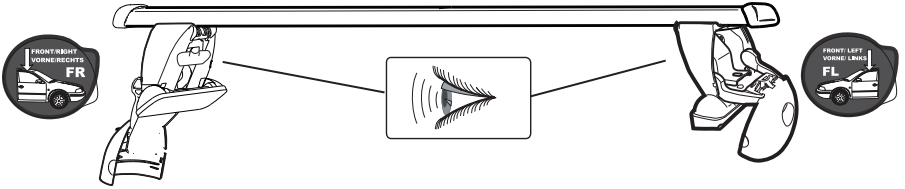
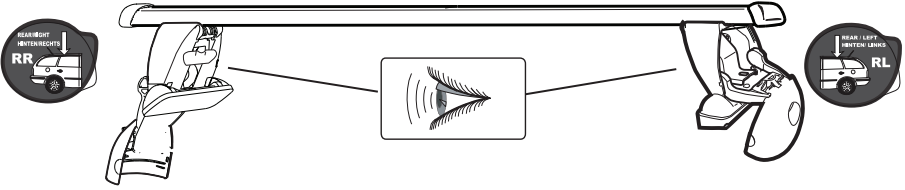

12

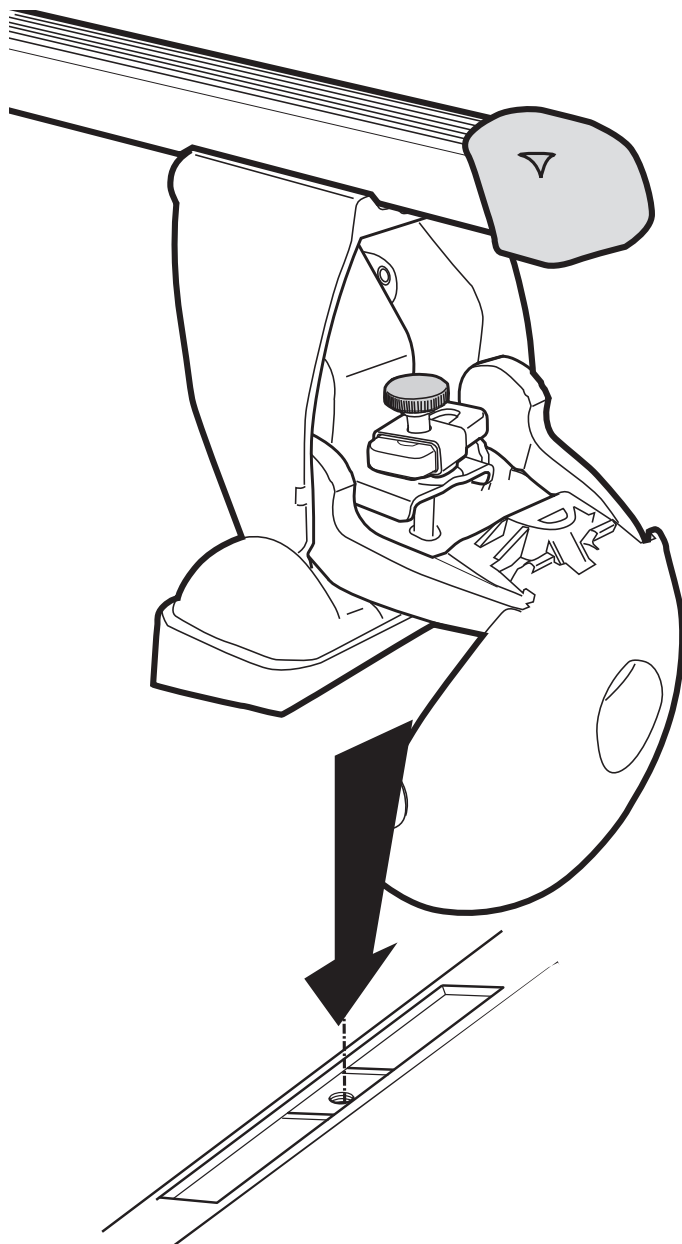

13

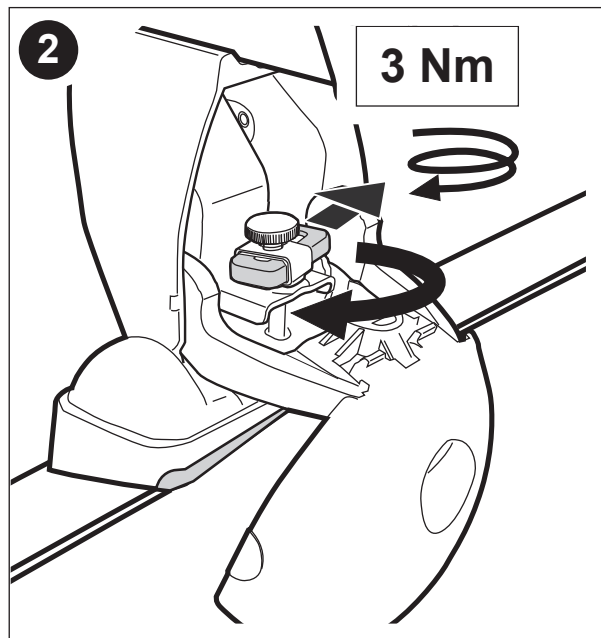
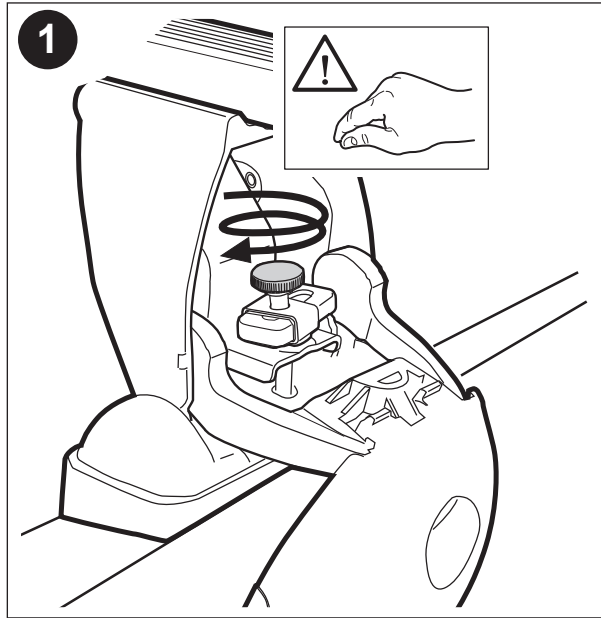

14

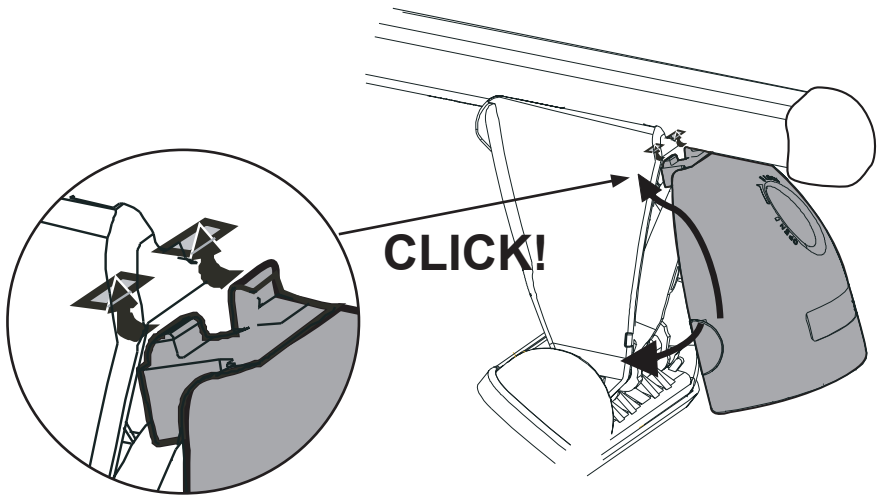

15

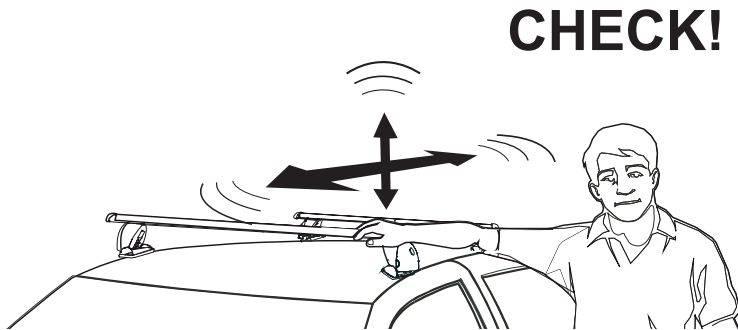

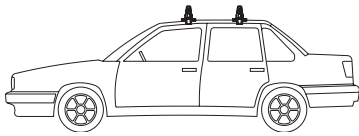

~20 km
←

CHECK!

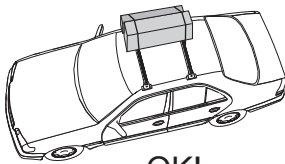
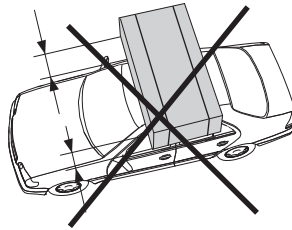
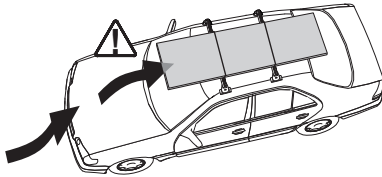
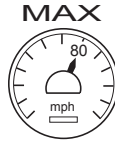
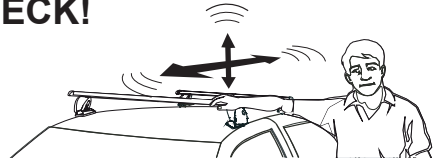

OK!

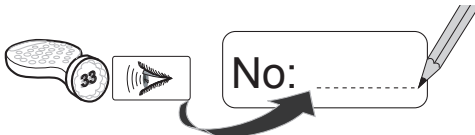
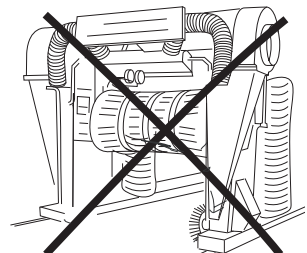
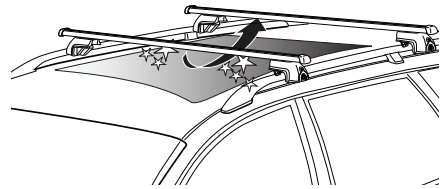
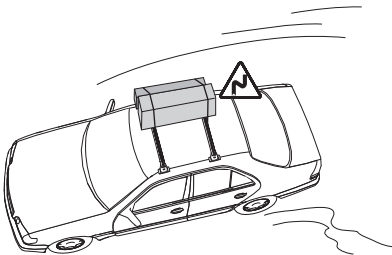
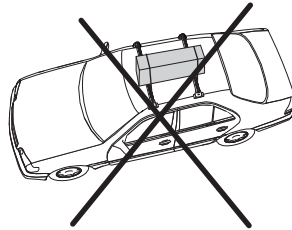

Ersatzteile • Spare parts • Reservdelar • Pièces de rechange • Запасные части
 • Varosat • Onderdeel • Piezas de recambio • Pezzi di ricambio • Części zamienne

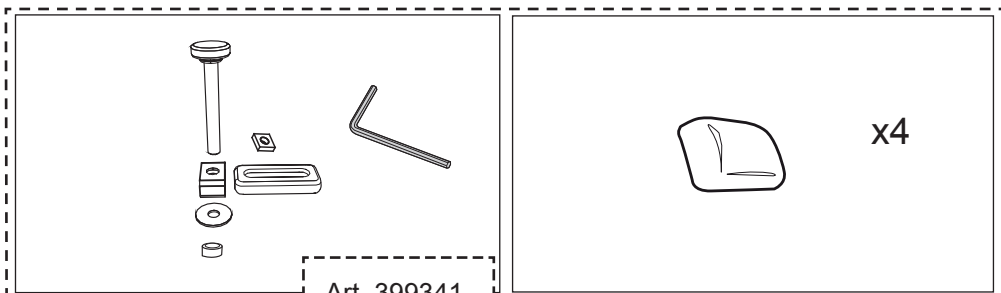

Art. 399341

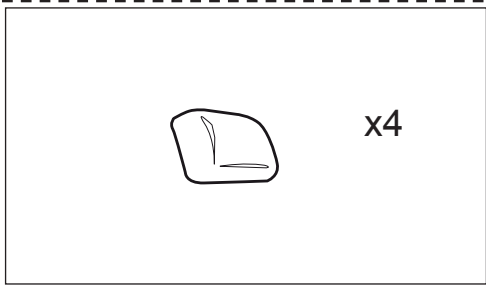

x4

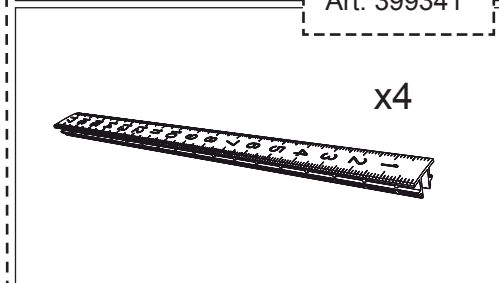

x4

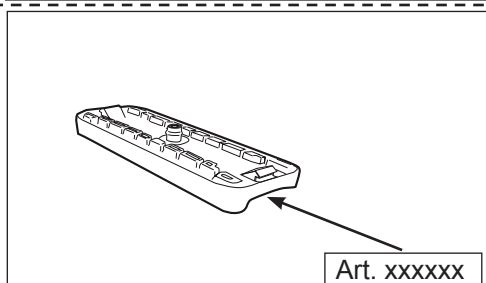

Art. xxxxxx

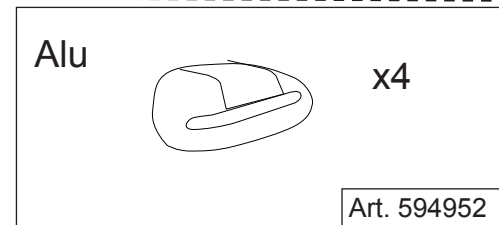

Art. 594952

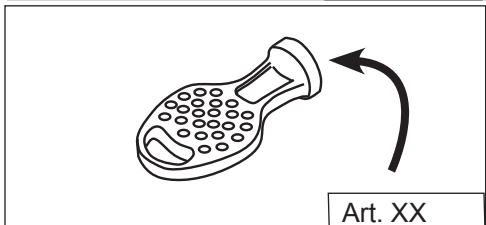

Art. XX

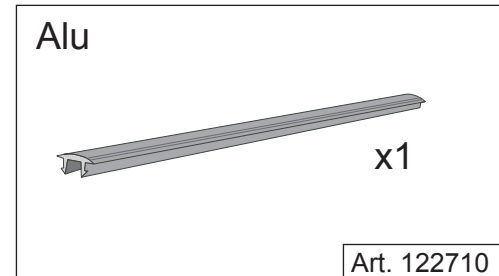

Art. 122710

Mont Blanc
 MB RoofBars Flex 3
 clamp foot BU2 - FK22

118 cm - Ersatz 1 für MBV 2016

DE Montagesanleitung	EE Avarrútolaj
FR Fiche instruction	ES Instrucciones de montaje
GB Mounting instruction	IT Istruzioni di montaggio
RU Инструкция по монтажу	PL Instrukcja montażu

www.montblancgroup.com

Zubehör • Accessories • Tillbehör • Accessoires • Аксессуары • Lisävarusteet
 • Accessoires • Accessorios • Accessori • Wyposażenie • Acessórios

 <p>Full range of Roofbars</p>	 <p>MB BikeCarrier RoofRush</p>
 <p>MB BikeCarrier RoofSprint</p>	 <p>MB RoofBox Altitude</p>
 <p>MB BikeCarrier TowQuick</p>	 <p>MB SnowSports Crest</p>
 <p>Accessories</p>	 <p>Accessories</p>

**Mont
Blanc**®

Sweden:
 Mont Blanc Industri AB
 Phone +46 33 222700

UK:
 Mont Blanc Industri UK Ltd
 Phone +44 1525 850800

France:
 Mont Blanc France SAS
 Phone +33 2 99211270

www.montblancgroup.com