

## Komplettierung Appendix Tillägg

FK 136

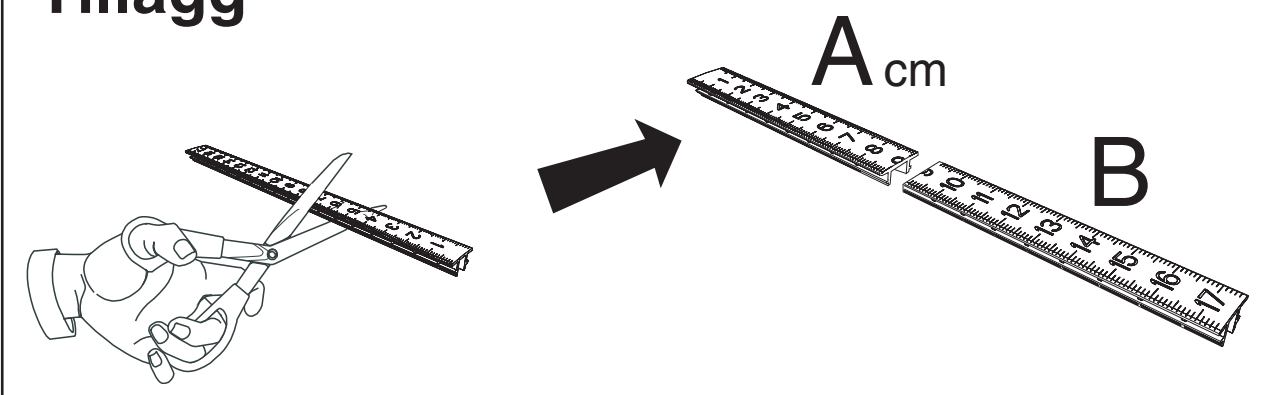
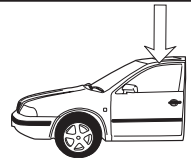
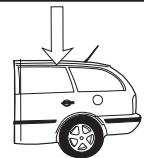
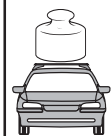

A Distance spacer / B slot cover  
A Distanz / B Schlitzschutz

Breiteneinstellung für Ihr Fahrzeug Width settings for your vehicle		 Spacer/Distanzen A Front/Vorne	 Spacer/Distanzen A Rear/Hinten	 Max load
CHEVROLET Colorado x-cab	04-	→ 3,9	2,4	50 kg
HOLDEN Rodeo	03-	→ 3,9	2,4	50 kg
ISUZU Rodeo D-max	02-	→ 3,9	2,4	50 kg

A cm

0611-150639-1

Montageabstand auf Ihrem Autodach (Siehe Liste)  
 Roof rack positions on the roof for your vehicle (see list)

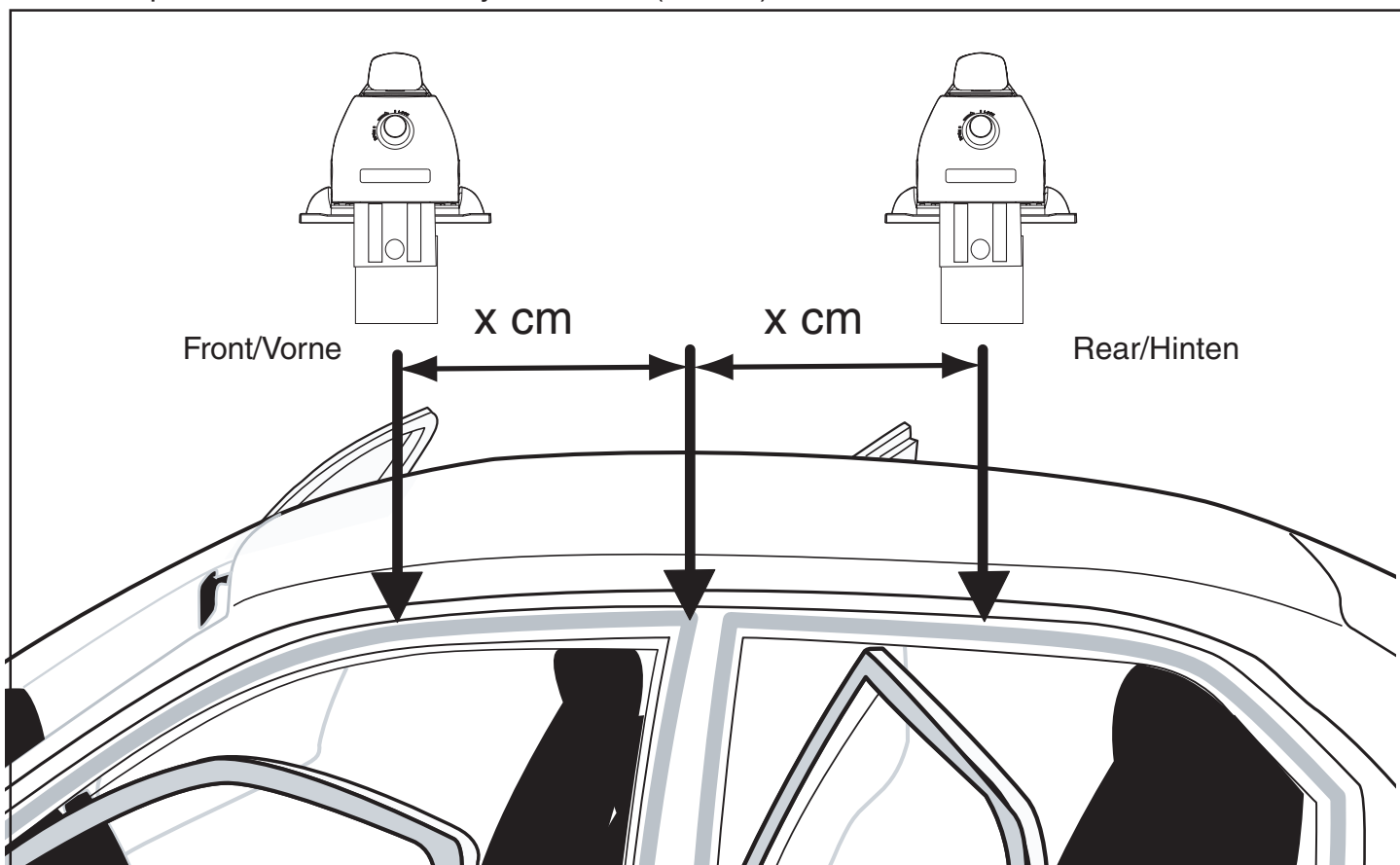

			Distance/Abstand Front/Vorne	Distance/Abstand Rear/Hinten
CHEVROLET	Colorado x-cab	04-	→ 25,0	45,0
HOLDEN	Rodeo	03-	→ 25,0	45,0
ISUZU	Rodeo D-max	02-	→ 25,0	45,0

cm cm

Montageabstand auf Ihrem Autodach (Siehe Liste)  
 Roof rack positions on the roof for your vehicle (see list)

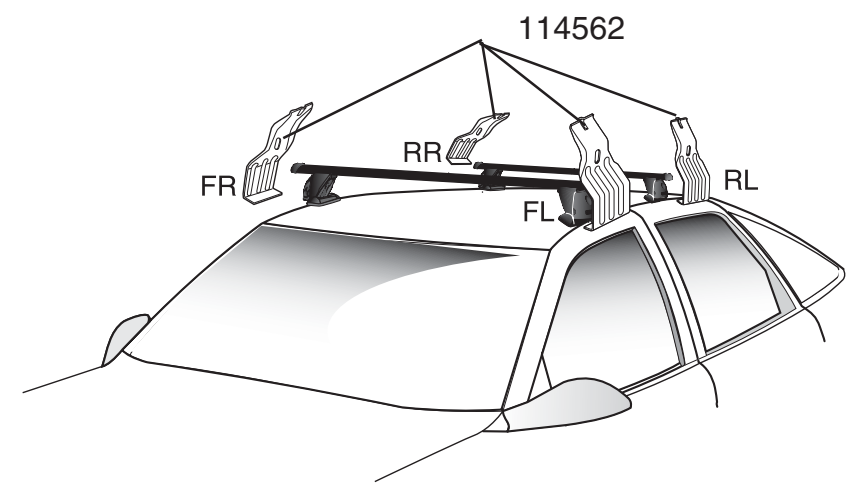
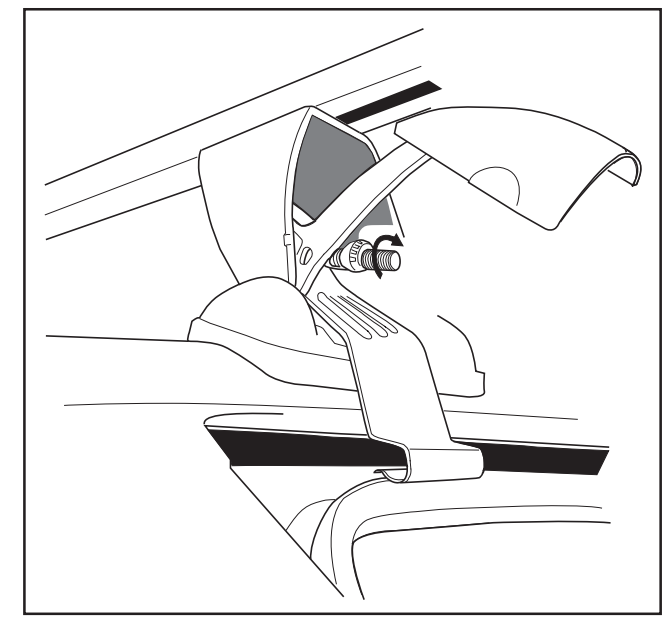

142602

